

**Pako Şalterler ve  
Pako Kutuları**  
Rotary Cam Switches

## PS Serisi Pako Şalterler

Genel Özellikler ve Teknik Bilgiler	3
Seçim Tablosu	4
“0 -1” Aç-Kapa Pako Şalterler - 60°	6
Emniyet Tipi Aç-Kapa Pako Şalterler - 90°	7
“1-2” Kutup Değişiriciler - 60°	8
“1-0-2” Kutup Değişiriciler - 60°	8
Kademeli Şalterler - 1 Faz	9
Kademeli Toplamalı Şalterler - 60°	10
Yıldız Üçgen Kumanda Şalterler - 60°	11
1 Faz Enversor Şalterler “1-0-2”	11
3 Faz Aç-Kapa Şalterler “0-1”	11
3 Faz Enversor Şalterler “1-0-2”	12
3 Faz Çift Devir Şalterler ( 0-1-2 )	12
3 Faz Çift Devir Şalterler ( 1-0-2 )	12
Ölçü Komütatörler - 45°	14
Aksesuarlar	14
Montaj Şekilleri ve Boyutları (mm)	14

## PS Series Rotary Cam Switches

General Specifications and Technical Information	3
Selection Table	4
0 -1 On-Off Cam Switches - 60°	6
0-1 Safety On-Off Cam Switches - 90°	7
1-2 Changeover Cam Switches - 60°	8
1-0-2 Changeover Cam Switches - 60°	8
Step Cam Switches - 1 Pole	9
Step Cam Switches- 60°	10
Star-Delta Cam Switches- 60°	11
1 Pole Enversor Cam Stwitches “1-0-2”	11
3 Poles On-Off Cam Switches “0-1”	11
3 Phase Enversor Cam Stwitches “1-0-2”	12
3 Phase Double Cycle Cam Switches (0-1-2)	12
3 Phase Double Cycle Cam Switches (1-0-2)	12
Measuring Cam Switches - 45°	14
Accessories	14
Assembly Type and Dimensions (mm)	14

## PS Serisi Pako Kutuları

PS Serisi Pako Kutuları	16
Montaj Ölçüleri (mm)	16
PS Serisi Pako Şalterler Teknik Özellikler	17
ÖZEL SİPARİŞ FORMU	18

## PS Series Rotary Cam Enclosures

PS Series Rotary Cam Switch Enclosures	16
Mounting Dimensions (mm)	16
PS Series Rotary Cam Switches Specifications	17
SPECIAL ORDER FORM	18



## PS Serisi Pako Şalterler

- Yüksek doğruluk
- Geniş uygulama alanları için ürün çeşitliliği
- Uzun ömür
- Yüksek kontak güvenilirliği
- Kompakt tasarım ve sağlamlık
- Parmak ergonomisine uygun tasarım ve kolay fark edilebilen kademeler

### Teknik Bilgiler

Mekanik Ömür	: 100.000 açma-kapama min. (15 dev/dk)
Elektriksel Ömür	: 50.000 açma-kapama min. (7,5 dev/dk)
Çalışma Sıcaklığı	: -5 / +40°C
Koruma Derecesi	: IP54 ve IP65 kutu içinde
Kısa Devre Kesme Kapasitesi	: 6kA
Çalışma Gerilimi (Ue)	: 220 - 400 V
Çalışma Akımı (Ie)	: 10 - 120 A
İzolasyon Direnci	: 10 MΩ min. (500 V DC)
Dielektrik Mukavemeti	: (1 dakika için) 1890 AC
Yalıtım Gerilimi (Ui)	: 690 V
Darbe Dayanım Gerilimi (Uimp)	: 4 kv
Kullanma Sınıfı	: AC21A - AC23A
Çalışma Frekansı	: 50 Hz.
Standart	: TS EN 60947-3



## PS Series Rotary Cam Switches

- High precision
- Variety of products for wide application fields
- Long life time
- High contact reliability
- Compact design and reliability
- Handle designed in conformity with finger ergonomics and easily perceivable grades

### Technical Information

Mechanical Life	: 100.000 operations min. (15 cycle/min.)
Electrical Life	: 50.000 operations min. (7,5 cycle/min.)
Operating Temperature	: -5 / +40°C
Protection Degree	: IP54 and IP65 (Front Protection)
Short Circuit Breaking Capacity	: 6 kA
Rated Operating Voltage (Ue)	: 220 - 400 V
Rated Operating Current (Ie)	: 10 - 120 A
Insulation Resistance	: 10 MΩ min. (500 V DC)
Dielectrical Strength	: (for 1 minute) 1890 AC
Insulation Voltage (Ui)	: 690 V
Impact Resistance (Uimp)	: 4 kv
Utilization Category	: AC21A - AC23A
Operating Frequency	: 50 Hz.
Standard	: TS EN 60947-3



# Pako Şalterler ve Pako Kutuları

## Rotary Cam Switches



### Pako Şalterlerin Seçim Tablosu

Rotary Cam Switches Selection Table

Grup	Terminal Tipi	Nominal Akım	Tip	Kutup / Kademe	Açı	Etiket	Opsiyon
<b>PS</b>	<b>A</b>	<b>010</b>	<b>AK</b>	<b>1</b>	<b>3</b>	<b>1</b>	<b>S</b>
Group	Terminal Type	Nominal Current	Type	Pole	Angle	Label	Option
<b>PS</b> Pako Şalterler Rotary Cam Switches	<b>A</b> Vidalı Screw <b>B</b> Terminalli Terminal <b>C</b> Yay Baskılı Spring Clamp	<b>010</b> 10 Ampere 10 Ampere <b>016</b> 16 Ampere 16 Ampere <b>020</b> 20 Ampere 20 Ampere <b>025</b> 25 Ampere 25 Ampere <b>032</b> 32 Ampere 32 Ampere <b>040</b> 40 Ampere 40 Ampere <b>050</b> 50 Ampere 50 Ampere <b>063</b> 63 Ampere 63 Ampere <b>080</b> 80 Ampere 80 Ampere <b>120</b> 120 Ampere 120 Ampere <b>160</b> 160 Ampere 160 Ampere <b>200</b> 200 Ampere 200 Ampere	<b>AK</b> Aç - Kapa On - Off <b>KD</b> Kutup Değiştirici Change-Over <b>KS</b> Kademeli Şalter Step <b>KT</b> Kademeli Toplamalı Multi Step <b>MS</b> Motor Şalteri Motor Control <b>CD</b> Çift Devir Double Speed Motor Switch <b>OK</b> Ölçü Komütatörü Measure Commutator <b>Z*</b> Özel Pako Special Cam Switch	<b>AK KT MS CD ve KD Şalterlerde</b> For AK KT MS CD and KD Switches <b>1</b> 1 Kutup 1 Pole <b>2</b> 2 Kutup 2 Poles <b>3</b> 3 Kutup 3 Poles <b>4</b> 4 Kutup 4 Poles <b>KS ve KT Şalterlerde</b> For KS and KT Switches <b>2</b> 2 Kademe 2 Step <b>3</b> 3 Kademe 3 Step <b>4</b> 4 Kademe 4 Step <b>5</b> 5 Kademe 5 Step <b>6</b> 6 Kademe 6 Step <b>7</b> 7 Kademe 7 Step <b>8</b> 8 Kademe 8 Step <b>9</b> 9 Kademe 9 Step <b>Z Şalterlerde</b> For Z Switches Sıra No	<b>1</b> 30° Açı 30° Angle <b>2</b> 45° Açı 45° Angle <b>3</b> 60° Açı 60° Angle <b>4</b> 90° Açı 90° Angle <b>5</b> 90° Açı (Yaylı Geri Dönüşlü) 90° Angle (Spring Return)	<b>S</b> 48x48 Normal 48x48 Normal <b>E</b> 48x48 Emniyet Sarı Kırmızı 48x48 Emergency Yellow-Red <b>B</b> 64x64 Normal 64x64 Normal <b>F</b> 64x64 Emniyet 64x64 Emergency <b>AQ</b> Anahtarlı Hızlı Montaj Key Operated Quick Installation <b>K</b> Tutamaktan Kilit Takılabilen Padlockable Handle <b>G</b> 48x48 Emniyet Gri Siyah 48x48 Emergency Grey-Black <b>Q</b> Hızlı Montaj 48x48 Normal Quick Installation 48x48 Normal <b>P</b> Hızlı Montaj 48x48 Emniyet Sarı Kırmızı Quick Installation 48x48 Emerg. Yellow-Red	<b>1</b> <b>2</b> <b>3</b> <b>4</b> <b>5</b> <b>6</b> <b>7</b>

## Pako Şalter Grupları

*Rotary Cam Switch Groups*



**48x48 Normal**



**64x64 Normal**



**PSK11**



**PSK12**



**AQ Anahtarlı Hızlı Montaj**  
*AQ Key Operated Quick Release*



**K Tutamaktan Kilit Takılabilen**  
*K Padlockable Handle*

# Pako Şalterler ve Pako Kutuları

## Rotary Cam Switches

EMES®

### "0 - 1" Aç-Kapa Pako Şalterler - 60° / 0 - 1 On-Off Cam Switches - 60°

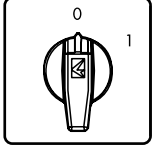

PSA020AK131S

Ürün Kodu	Faz Sayısı	Anma Termik Akımı (A)	Uygun Kutu Kodu	Anahtarlı Kafa Uyarlanabilir	Çabuk Montaj	Kontakt Şeması
Code	Poles	Rated Thermal Current (A)	Enclosure	Key Operated	Quick Installation	Scheme
PSA010AK131S	1 Faz / Pole	10	PSK11	✓	✓	
PSA016AK131S	1 Faz / Pole	16	PSK11	✓	✓	
PSA020AK131S	1 Faz / Pole	20	PSK11	✓	✓	
PSA025AK131S	1 Faz / Pole	25	PSK11	✓	✓	
PSA032AK131S	1 Faz / Pole	32	PSK21			
PSA040AK131S	1 Faz / Pole	40	PSK21			
PSA050AK131S	1 Faz / Pole	50	-			
PSA063AK131S	1 Faz / Pole	63	-			
PSA080AK131S	1 Faz / Pole	80	-			
PSA120AK131S	1 Faz / Pole	120	-			



PSA020AK231S

PSA010AK231S	2 Faz / Poles	10	PSK11	✓	✓	
PSA016AK231S	2 Faz / Poles	16	PSK11	✓	✓	
PSA020AK231S	2 Faz / Poles	20	PSK11	✓	✓	
PSA025AK231S	2 Faz / Poles	25	PSK11	✓	✓	
PSA032AK231S	2 Faz / Poles	32	PSK21			
PSA040AK231S	2 Faz / Poles	40	PSK21			
PSA050AK231S	2 Faz / Poles	50	-			
PSA063AK231S	2 Faz / Poles	63	-			
PSA080AK231S	2 Faz / Poles	80	-			
PSA120AK231S	2 Faz / Poles	120	-			



PSA020AK331S

PSA010AK331S	3 Faz / Poles	10	PSK11	✓	✓	
PSA016AK331S	3 Faz / Poles	16	PSK11	✓	✓	
PSA020AK331S	3 Faz / Poles	20	PSK11	✓	✓	
PSA025AK331S	3 Faz / Poles	25	PSK11	✓	✓	
PSA032AK331S	3 Faz / Poles	32	PSK21			
PSA040AK331S	3 Faz / Poles	40	PSK21			
PSA050AK331S	3 Faz / Poles	50	-			
PSA063AK331S	3 Faz / Poles	63	-			
PSA080AK331S	3 Faz / Poles	80	-			
PSA120AK331S	3 Faz / Poles	120	-			



PSA020AK431S

PSA010AK431S	4 Faz / Poles	10	PSK11	✓	✓	
PSA016AK431S	4 Faz / Poles	16	PSK11	✓	✓	
PSA020AK431S	4 Faz / Poles	20	PSK11	✓	✓	
PSA025AK431S	4 Faz / Poles	25	PSK11	✓	✓	
PSA032AK431S	4 Faz / Poles	32	PSK21			
PSA040AK431S	4 Faz / Poles	40	PSK21			
PSA050AK431S	4 Faz / Poles	50	-			
PSA063AK431S	4 Faz / Poles	63	-			
PSA080AK431S	4 Faz / Poles	80	-			
PSA120AK431S	4 Faz / Poles	120	-			



PSA020AK831S

PSA010AK831S	3 Faz+Nötr / Poles+Neutral	10	PSK11	✓	✓	
PSA016AK831S	3 Faz+Nötr / Poles+Neutral	16	PSK11	✓	✓	
PSA020AK831S	3 Faz+Nötr / Poles+Neutral	20	PSK11	✓	✓	
PSA025AK831S	3 Faz+Nötr / Poles+Neutral	25	PSK11	✓	✓	
PSA032AK831S	3 Faz+Nötr / Poles+Neutral	32	PSK21			
PSA040AK831S	3 Faz+Nötr / Poles+Neutral	40	PSK21			
PSA050AK831S	3 Faz+Nötr / Poles+Neutral	50	-			
PSA063AK831S	3 Faz+Nötr / Poles+Neutral	63	-			
PSA080AK831S	3 Faz+Nötr / Poles+Neutral	80	-			
PSA120AK831S	3 Faz+Nötr / Poles+Neutral	120	-			

- İstendiği takdirde sarı kırmızı kafa ile tedarik edilir. Bu durumda son harf "S" yerine "E" olmalıdır.
- *Could be supplied with Red-Yellow head w/o extra charge, in this case please replace the "S" at the end with "E"*
- İstendiği takdirde, 10-25A bir büyük boy çerçeve ile montaj yapılabilir (64x64), bu durumda sondaki "S" yerine "B" konması gerekmektedir.
- *10-25A Cam switches could be supplied with big frame (64x64) with extra charge. In this case please replace the "S" at the end with "B".*
- Anahtarlı sütunda işaretli olan modeller çabuk montajlı Anahtarlı Kafa için uygundur.
- Products in the Key Operated column are available for quick release Key Head.
- K tutamaktan kilit takılabilen modellerde sondaki "S" yerine "K" konması gerekmektedir.
- Please replace "S" letter at the end of the code with "K" for Lockable Handle model.
- Q Çabuk montajlı modellerde sondaki "S" yerine "Q" konması gerekmektedir.
- Please replace "S" letter at the end of the code with "Q" letter for quick installation model.

# Pako Şalterler ve Pako Kutuları

## Rotary Cam Switches

EMES®

### Emniyet Tipi Aç-Kapa Pako Şalterler - 90° / 0-1 Safety On-Off Cam Switches - 90°

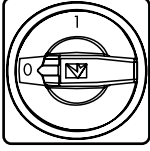

PSA020AK141E



Ürün Kodu Code	Faz Sayısı Poles	Anma Termik Akımı (A) Rated Thermal Current (A)	Uygun Kutu Kodu Enclosure	Anahtarlı Kafa Uyarlanabilir Key Operated	Çabuk Montaj Quick Installation	Kontakt Şeması Scheme
PSA010AK141E	1 Faz / Pole	10	PSK11		✓	
PSA016AK141E	1 Faz / Pole	16	PSK11		✓	
PSA020AK141E	1 Faz / Pole	20	PSK11		✓	
PSA025AK141E	1 Faz / Pole	25	PSK11		✓	
PSA032AK141E	1 Faz / Pole	32	PSK21			
PSA040AK141E	1 Faz / Pole	40	PSK21			
PSA050AK141E	1 Faz / Pole	50	-			
PSA063AK141E	1 Faz / Pole	63	-			
PSA080AK141E	1 Faz / Pole	80	-			
PSA120AK141E	1 Faz / Pole	120	-			

PSA020AK241E



PSA010AK241E	2 Faz / Poles	10	PSK11		✓	
PSA016AK241E	2 Faz / Poles	16	PSK11		✓	
PSA020AK241E	2 Faz / Poles	20	PSK11		✓	
PSA025AK241E	2 Faz / Poles	25	PSK11		✓	
PSA032AK241E	2 Faz / Poles	32	PSK21			
PSA040AK241E	2 Faz / Poles	40	PSK21			
PSA050AK241E	2 Faz / Poles	50	-			
PSA063AK241E	2 Faz / Poles	63	-			
PSA080AK241E	2 Faz / Poles	80	-			
PSA120AK241E	2 Faz / Poles	120	-			

PSA020AK341E



PSA010AK341E	3 Faz / Poles	10	PSK11		✓	
PSA016AK341E	3 Faz / Poles	16	PSK11		✓	
PSA020AK341E	3 Faz / Poles	20	PSK11		✓	
PSA025AK341E	3 Faz / Poles	25	PSK11		✓	
PSA032AK341E	3 Faz / Poles	32	PSK21			
PSA040AK341E	3 Faz / Poles	40	PSK21			
PSA050AK341E	3 Faz / Poles	50	-			
PSA063AK341E	3 Faz / Poles	63	-			
PSA080AK341E	3 Faz / Poles	80	-			
PSA120AK341E	3 Faz / Poles	120	-			

PSA020AK441E



PSA010AK441E	4 Faz / Poles	10	PSK11		✓	
PSA016AK441E	4 Faz / Poles	16	PSK11		✓	
PSA020AK441E	4 Faz / Poles	20	PSK11		✓	
PSA025AK441E	4 Faz / Poles	25	PSK11		✓	
PSA032AK441E	4 Faz / Poles	32	PSK21			
PSA040AK441E	4 Faz / Poles	40	PSK21			
PSA050AK441E	4 Faz / Poles	50	-			
PSA063AK441E	4 Faz / Poles	63	-			
PSA080AK441E	4 Faz / Poles	80	-			
PSA120AK441E	4 Faz / Poles	120	-			

PSA020AK941E



PSA010AK941E	3 Faz+Nötr / Poles+Neutral	10	PSK11		✓	
PSA016AK941E	3 Faz+Nötr / Poles+Neutral	16	PSK11		✓	
PSA020AK941E	3 Faz+Nötr / Poles+Neutral	20	PSK11		✓	
PSA025AK941E	3 Faz+Nötr / Poles+Neutral	25	PSK11		✓	
PSA032AK941E	3 Faz+Nötr / Poles+Neutral	32	PSK21			
PSA040AK941E	3 Faz+Nötr / Poles+Neutral	40	PSK21			
PSA050AK941E	3 Faz+Nötr / Poles+Neutral	50	-			
PSA063AK941E	3 Faz+Nötr / Poles+Neutral	63	-			
PSA080AK941E	3 Faz+Nötr / Poles+Neutral	80	-			
PSA120AK941E	3 Faz+Nötr / Poles+Neutral	120	-			

- İstendiği takdirde, 10-25A bir büyük boy çerçeve ile montaj yapılabilir (64x64), bu durumda sondaki "E" yerine "F" konması gerekmektedir.
- 10-25A Cam switches could be supplied with big frame (64x64). In this case please replace the "E" at the end with "F".

- Anahtarlı sütunda işaretli olan modeller çabuk montajlı Anahtarlı Kafa için uygundur.
- Products in the Key Operated column are available for quick release Key Head.

- Çabuk montajlı modellerde sondaki "E" yerine "P" konması gerekmektedir.
- Please replace "E" letter at the end of the code with "P" letter for quick installation model.

# Pako Şalterler ve Pako Kutuları

## Rotary Cam Switches

EMES®

### "1-2" Kutup Değiştiriciler - 60° / 1-2 Changeover Cam Switches - 60°

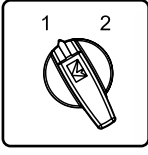

PSA020KD133S

Ürün Kodu	Faz Sayısı	Anma Termik Akımı (A)	Uygun Kutu Kodu	Anahtarlı Kafa Uyarlanabilir	Çabuk Montaj	Kontak Şeması
Code	Poles	Rated Thermal Current (A)	Enclosure	Key Operated	Quick Installation	Scheme
PSA010KD133S	1 Faz / Pole	10	PSK11		✓	
PSA016KD133S	1 Faz / Pole	16	PSK11		✓	
PSA020KD133S	1 Faz / Pole	20	PSK11		✓	
PSA025KD133S	1 Faz / Pole	25	PSK11		✓	
PSA032KD133S	1 Faz / Pole	32	PSK21			
PSA040KD133S	1 Faz / Pole	40	PSK21			
PSA050KD133S	1 Faz / Pole	50	-			
PSA063KD133S	1 Faz / Pole	63	-			
PSA080KD133S	1 Faz / Pole	80	-			
PSA120KD133S	1 Faz / Pole	120	-			

PSA010KD233S	2 Faz / Poles	10	PSK11		✓	
PSA016KD233S	2 Faz / Poles	16	PSK11		✓	
PSA020KD233S	2 Faz / Poles	20	PSK11		✓	
PSA025KD233S	2 Faz / Poles	25	PSK11		✓	
PSA032KD233S	2 Faz / Poles	32	-			
PSA040KD233S	2 Faz / Poles	40	-			
PSA050KD233S	2 Faz / Poles	50	-			
PSA063KD233S	2 Faz / Poles	63	-			
PSA080KD233S	2 Faz / Poles	80	-			



PSA020KD333S

PSA010KD333S	3 Faz / Poles	10	PSK12		✓	
PSA016KD333S	3 Faz / Poles	16	PSK12		✓	
PSA020KD333S	3 Faz / Poles	20	PSK12		✓	
PSA025KD333S	3 Faz / Poles	25	PSK12		✓	
PSA032KD333S	3 Faz / Poles	32	-			
PSA040KD333S	3 Faz / Poles	40	-			
PSA050KD333S	3 Faz / Poles	50	-			
PSA063KD333S	3 Faz / Poles	63	-			
PSA080KD333S	3 Faz / Poles	80	-			

### "1-0-2" Kutup Değiştiriciler - 60° / 1-0-2 Changeover Cam Switches - 60°

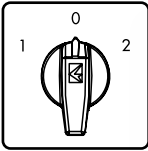

PSA020KD134S

Ürün Kodu	Faz Sayısı	Anma Termik Akımı (A)	Uygun Kutu Kodu	Anahtarlı Kafa Uyarlanabilir	Çabuk Montaj	Kontak Şeması
Code	Poles	Rated Thermal Current (A)	Enclosure	Key Operated	Quick Installation	Scheme
PSA010KD134S	1 Faz / Pole	10	PSK11	✓	✓	
PSA016KD134S	1 Faz / Pole	16	PSK11	✓	✓	
PSA020KD134S	1 Faz / Pole	20	PSK11	✓	✓	
PSA025KD134S	1 Faz / Pole	25	PSK11	✓	✓	
PSA032KD134S	1 Faz / Pole	32	PSK21			
PSA040KD134S	1 Faz / Pole	40	PSK21			
PSA050KD134S	1 Faz / Pole	50	-			
PSA063KD134S	1 Faz / Pole	63	-			
PSA080KD134S	1 Faz / Pole	80	-			
PSA120KD134S	1 Faz / Pole	120	-			



PSA020KD234S

PSA010KD234S	2 Faz / Poles	10	PSK11	✓	✓	
PSA016KD234S	2 Faz / Poles	16	PSK11	✓	✓	
PSA020KD234S	2 Faz / Poles	20	PSK11	✓	✓	
PSA025KD234S	2 Faz / Poles	25	PSK11	✓	✓	
PSA032KD234S	2 Faz / Poles	32	PSK21			
PSA040KD234S	2 Faz / Poles	40	PSK21			
PSA050KD234S	2 Faz / Poles	50	-			
PSA063KD234S	2 Faz / Poles	63	-			
PSA080KD234S	2 Faz / Poles	80	-			
PSA120KD234S	2 Faz / Poles	120	-			

- İstendiği takdirde sarı kırmızı kafa ile tedarik edilir. Bu durumda son harf "S" yerine "E" olmalıdır. Fiyat farkı uygulanmamaktadır.
- *Could be supplied with Red-Yellow head w/o extra charge, in this case please replace the "S" at the end with "E"*

- İstendiği takdirde, 10-25A bir büyük boy çerçeve ile montaj yapılabilir (64x64), bu durumda sondaki "S" yerine "B" konması gerekmektedir.
- *10-25A Cam switches could be supplied with big frame (64x64) with extra charge. In this case please replace the "S" at the end with "B".*

- Anahtarlı sütunda işaretli olan modeller çabuk montajlı Anahtarlı Kafa için uygundur.
- *Products in the Key Operated column are available for quick release Key Head.*

- Q Çabuk montajlı modellerde sondaki "S" yerine "Q" konması gerekmektedir.
- *Please replace "S" letter at the end of the code with "Q" letter for quick installation model.*



# Pako Şalterler ve Pako Kutuları

## Rotary Cam Switches

EMES®



PSA020KD334S

Ürün Kodu	Faz Sayısı	Anma Termik Akımı (A)	Uygun Kutu Kodu	Anahtarlı Kafa Uyarlanabilir	Çabuk Montaj	Kontak Şeması
Code	Poles	Rated Thermal Current (A)	Enclosure	Key Operated	Quick Installation	Scheme
PSA010KD334S	3 Faz / Poles	10	PSK12	✓	✓	
PSA016KD334S	3 Faz / Poles	16	PSK12	✓	✓	
PSA020KD334S	3 Faz / Poles	20	PSK12	✓	✓	
PSA025KD334S	3 Faz / Poles	25	PSK12	✓	✓	
PSA032KD334S	3 Faz / Poles	32	PSK22			
PSA040KD334S	3 Faz / Poles	40	PSK22			
PSA050KD334S	3 Faz / Poles	50	-			
PSA063KD334S	3 Faz / Poles	63	-			
PSA080KD334S	3 Faz / Poles	80	-			
PSA120KD334S	3 Faz / Poles	120	-			



PSA020KD434S

Ürün Kodu	Faz Sayısı	Anma Termik Akımı (A)	Uygun Kutu Kodu	Anahtarlı Kafa Uyarlanabilir	Çabuk Montaj	Kontak Şeması
Code	Poles	Rated Thermal Current (A)	Enclosure	Key Operated	Quick Installation	Scheme
PSA010KD434S	4 Faz / Poles	10	PSK12	✓	✓	
PSA016KD434S	4 Faz / Poles	16	PSK12	✓	✓	
PSA020KD434S	4 Faz / Poles	20	PSK12	✓	✓	
PSA025KD434S	4 Faz / Poles	25	PSK12	✓	✓	
PSA032KD434S	4 Faz / Poles	32	PSK22			
PSA040KD434S	4 Faz / Poles	40	PSK22			
PSA050KD434S	4 Faz / Poles	50	-			
PSA063KD434S	4 Faz / Poles	63	-			
PSA080KD434S	4 Faz / Poles	80	-			
PSA120KD434S	4 Faz / Poles	120	-			

### Kademeli Şalterler - 1 Faz / Step Cam Switches - 1 Pole

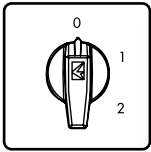

PSA020KS132S

Ürün Kodu	Kutup Sayısı	Anma Termik Akımı (A)	Uygun Kutu Kodu	Anahtarlı Kafa Uyarlanabilir	Çabuk Montaj	Kontak Şeması
Code	Steps	Rated Thermal Current (A)	Enclosure	Key Operated	Quick Installation	Scheme
PSA010KS132S	0-2	10	PSK11	✓	✓	
PSA016KS132S	0-2	16	PSK11	✓	✓	
PSA020KS132S	0-2	20	PSK11	✓	✓	
PSA025KS132S	0-2	25	PSK11	✓	✓	
PSA032KS132S	0-2	32	PSK21			
PSA040KS132S	0-2	40	PSK21			
PSA050KS132S	0-2	50	-			
PSA063KS132S	0-2	63	-			
PSA080KS132S	0-2	80	-			
PSA120KS132S	0-2	120	-			

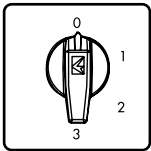

PSA020KS133S

Ürün Kodu	Kutup Sayısı	Anma Termik Akımı (A)	Uygun Kutu Kodu	Anahtarlı Kafa Uyarlanabilir	Çabuk Montaj	Kontak Şeması
Code	Steps	Rated Thermal Current (A)	Enclosure	Key Operated	Quick Installation	Scheme
PSA010KS133S	0-3	10	PSK11	✓	✓	
PSA016KS133S	0-3	16	PSK11	✓	✓	
PSA020KS133S	0-3	20	PSK11	✓	✓	
PSA025KS133S	0-3	25	PSK11	✓	✓	
PSA032KS133S	0-3	32	PSK21			
PSA040KS133S	0-3	40	PSK21			
PSA050KS133S	0-3	50	-			
PSA063KS133S	0-3	63	-			
PSA080KS133S	0-3	80	-			
PSA120KS133S	0-3	120	-			

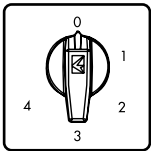

PSA020KS134S

Ürün Kodu	Kutup Sayısı	Anma Termik Akımı (A)	Uygun Kutu Kodu	Anahtarlı Kafa Uyarlanabilir	Çabuk Montaj	Kontak Şeması
Code	Steps	Rated Thermal Current (A)	Enclosure	Key Operated	Quick Installation	Scheme
PSA010KS134S	0-4	10	PSK12	✓	✓	
PSA016KS134S	0-4	16	PSK12	✓	✓	
PSA020KS134S	0-4	20	PSK12	✓	✓	
PSA025KS134S	0-4	25	PSK12	✓	✓	
PSA032KS134S	0-4	32	PSK22			
PSA040KS134S	0-4	40	PSK22			
PSA050KS134S	0-4	50	-			
PSA063KS134S	0-4	63	-			
PSA080KS134S	0-4	80	-			
PSA120KS134S	0-4	120	-			

• İstendiği takdirde sarı kırmızı kafa ile tedarik edilir. Bu durumda son harf "S" yerine "E" olmalıdır. Fiyat farkı uygulanmamaktadır.  
 • Could be supplied with Red-Yellow head w/o extra charge, in this case please replace the "S" at the end with "E"

•• İstendiği takdirde, 10-25A bir büyük boy çerçeve ile montaj yapılabilir (64x64), bu durumda sondaki "S" yerine "B" konması gerekmektedir.  
 •• 10-25A Cam switches could be supplied with big frame (64x64) with extra charge. In this case please replace the "S" at the end with "B".

••• Anahtarlı sütunda işaretli olan modeller çabuk montajlı Anahtarlı Kafa için uygundur.  
 ••• Products in the Key Operated column are available for quick release Key Head.

•••• Q Çabuk montajlı modellerde sondaki "S" yerine "Q" konması gerekmektedir.  
 •••• Please replace "S" letter at the end of the code with "Q" letter for quick installation model.

G

# Pako Şalterler ve Pako Kutuları

## Rotary Cam Switches

EMES®

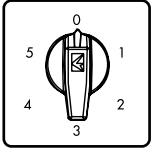

PSA020KS135S



Ürün Kodu	Kutup Sayısı	Anma Termik Akımı (A)	Uygun Kutu Kodu	Anahtarlı Kafa Uyarlanabilir	Çabuk Montaj	Kontak Şeması
Code	Steps	Rated Thermal Current (A)	Enclosure	Key Operated	Quick Installation	Scheme
PSA010KS135S	0-5	10	PSK12	✓	✓	
PSA016KS135S	0-5	16	PSK12	✓	✓	
PSA020KS135S	0-5	20	PSK12	✓	✓	
PSA025KS135S	0-5	25	PSK12	✓	✓	
PSA032KS135S	0-5	32	PSK22			
PSA040KS135S	0-5	40	PSK22			
PSA050KS135S	0-5	50	-			
PSA063KS135S	0-5	63	-			
PSA080KS135S	0-5	80	-			
PSA120KS135S	0-5	120	-			

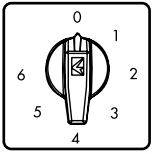

PSA020KS126S



PSA010KS126S	0-6	10	PSK12		✓	
PSA016KS126S	0-6	16	PSK12		✓	
PSA020KS126S	0-6	20	PSK12		✓	
PSA025KS126S	0-6	25	PSK12			
PSA032KS126S	0-6	32	PSK22			
PSA040KS126S	0-6	40	PSK22			
PSA050KS126S	0-6	50	-			
PSA063KS126S	0-6	63	-			
PSA080KS126S	0-6	80	-			
PSA120KS126S	0-6	120	-			

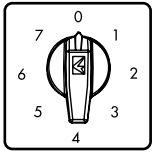

PSA020KS127S



PSA010KS127S	0-7	10	PSK12		✓	
PSA016KS127S	0-7	16	PSK12		✓	
PSA020KS127S	0-7	20	PSK12		✓	
PSA025KS127S	0-7	25	PSK12		✓	
PSA032KS127S	0-7	32	PSK22			
PSA040KS127S	0-7	40	PSK22			
PSA050KS127S	0-7	50	-			
PSA063KS127S	0-7	63	-			
PSA080KS127S	0-7	80	-			
PSA120KS127S	0-7	120	-			

### Kademeli Toplamalı Şalterler - 60° / Step Cam Switches- 60°

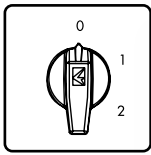

PSA020KT132S



Ürün Kodu	Kutup Sayısı	Anma Termik Akımı (A)	Kademe	Uygun Kutu Kodu	Anahtarlı Kafa Uyarlanabilir	Çabuk Montaj	Kontak Şeması
Code	Poles	Rated Thermal Current (A)	Steps	Enclosure	Key Operated	Quick Installation	Scheme
PSA010KT132S	1 Kutup / Pole	10	0-1-2	PSK11	✓	✓	
PSA016KT132S	1 Kutup / Pole	16	0-1-2	PSK11	✓	✓	
PSA020KT132S	1 Kutup / Pole	20	0-1-2	PSK11	✓	✓	
PSA025KT132S	1 Kutup / Pole	25	0-1-2	PSK11	✓	✓	
PSA010KT332S	3 Kutup / Poles	10	0-1-2	PSK12	✓		
PSA016KT332S	3 Kutup / Poles	16	0-1-2	PSK12	✓		

- İstendiği takdirde sarı kırmızı kafa ile tedarik edilir. Bu durumda son harf "S" yerine "E" olmalıdır. Fiyat farkı uygulanmamaktadır.
- *Could be supplied with Red-Yellow head w/o extra charge, in this case please replace the "S" at the end with "E"*
- İstendiği takdirde, 10-25A bir büyük boy çerçeve ile montaj yapılabilir (64x64), bu durumda sondaki "S" yerine "B" konması gerekmektedir.
- *10-25A Cam switches could be supplied with big frame (64x64) with extra charge. In this case please replace the "S" at the end with "B".*
- Anahtarlı sütunda işaretli olan modeller çabuk montajlı Anahtarlı Kafa için uygundur.
- *Products in the Key Operated column are available for quick release Key Head.*
- Q Çabuk montajlı modellerde sondaki "S" yerine "Q" konması gerekmektedir.
- *Please replace "S" letter at the end of the code with "Q" letter for quick installation model.*

### Yıldız Üçgen Kumanda Şalterler - 60° / Star-Delta Cam Switches- 60°

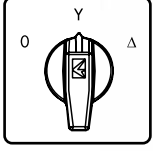

PSA020MS335S



Ürün Kodu	Faz Sayısı	Anma Termik Akımı (A)	Uygun Kutu Kodu	Anahtarlı Kafa Uyarlanabilir	Çabuk Montaj	Kontak Şeması
Code	Steps	Rated Thermal Current (A)	Enclosure	Key Operated	Quick Installation	Scheme
PSA010MS335S	3 Faz / Phase	10	PSK12	✓	✓	
PSA016MS335S	3 Faz / Phase	16	PSK12	✓	✓	
PSA020MS335S	3 Faz / Phase	20	PSK12	✓	✓	
PSA025MS335S	3 Faz / Phase	25	PSK12	✓	✓	
PSA032MS335S	3 Faz / Phase	32	PSK22			
PSA040MS335S	3 Faz / Phase	40	PSK22			
PSA050MS335S	3 Faz / Phase	50	-			
PSA063MS335S	3 Faz / Phase	63	-			
PSA080MS335S	3 Faz / Phase	80	-			
PSA120MS335S	3 Faz / Phase	120	-			

### 1 Faz Inversör Şalterler "1-0-2" / 1 Pole Changeover Cam Switches "1-0-2"

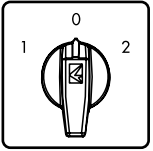

PSA020MS134S



Ürün Kodu	Faz Sayısı	Anma Termik Akımı (A)	Kademe	Uygun Kutu Kodu	Anahtarlı Kafa Uyarlanabilir	Çabuk Montaj	Kontak Şeması
Code	Poles	Rated Thermal Current (A)	Steps	Enclosure	Key Operated	Quick Installation	Scheme
PSA010MS134S	1 Faz / Phase	10	1-0-2	PSK11	✓	✓	
PSA016MS134S	1 Faz / Phase	16	1-0-2	PSK11	✓	✓	
PSA020MS134S	1 Faz / Phase	20	1-0-2	PSK11	✓	✓	
PSA025MS134S	1 Faz / Phase	25	1-0-2	PSK11	✓	✓	
PSA032MS134S	1 Faz / Phase	32	1-0-2	PSK21			
PSA040MS134S	1 Faz / Phase	40	1-0-2	PSK21			
PSA050MS134S	1 Faz / Phase	50	-	-			
PSA063MS134S	1 Faz / Phase	63	-	-			
PSA080MS134S	1 Faz / Phase	80	-	-			
PSA120MS134S	1 Faz / Phase	120	-	-			

### 3 Faz Aç-Kapa Şalterler "0-1" / 3 Poles On-Off Cam Switches "0-1"

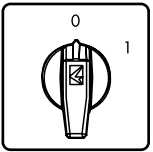

PSA020MS331S



Ürün Kodu	Faz Sayısı	Anma Termik Akımı (A)	Kademe	Uygun Kutu Kodu	Anahtarlı Kafa Uyarlanabilir	Çabuk Montaj	Kontak Şeması
Code	Poles	Rated Thermal Current (A)	Steps	Enclosure	Key Operated	Quick Installation	Scheme
PSA010MS331S	3 Faz / Phase	10	0-1	PSK11	✓	✓	
PSA016MS331S	3 Faz / Phase	16	0-1	PSK11	✓	✓	
PSA020MS331S	3 Faz / Phase	20	0-1	PSK11	✓	✓	
PSA025MS331S	3 Faz / Phase	25	0-1	PSK11	✓	✓	
PSA032MS331S	3 Faz / Phase	32	0-1	PSK21			
PSA040MS331S	3 Faz / Phase	40	0-1	PSK21			
PSA050MS331S	3 Faz / Phase	50	-	-			
PSA063MS331S	3 Faz / Phase	63	-	-			
PSA080MS331S	3 Faz / Phase	80	-	-			
PSA120MS331S	3 Faz / Phase	120	-	-			

- İstendiği takdirde sarı kırmızı kafa ile tedarik edilir. Bu durumda son harf "S" yerine "E" olmalıdır. Fiyat farkı uygulanmamaktadır.
- *Could be supplied with Red-Yellow head w/o extra charge, in this case please replace the "S" at the end with "E"*
- İstendiği takdirde, 10-25A bir büyük boy çerçeve ile montaj yapılabilir (64x64), bu durumda sondaki "S" yerine "B" konması gerekmektedir.
- *10-25A Cam switches could be supplied with big frame (64x64) with extra charge. In this case please replace the "S" at the end with "B".*
- Anahtarlı sütunda işaretli olan modeller çabuk montajlı Anahtarlı Kafa için uygundur.
- *Products in the Key Operated column are available for quick release Key Head.*
- Q Çabuk montajlı modellerde sondaki "S" yerine "Q" konması gerekmektedir.
- *Please replace "S" letter at the end of the code with "Q" letter for quick installation model.*

### 3 Faz Enversor Şalterler "1-0-2" / 3 Phase Changeover Cam Switches "1-0-2"

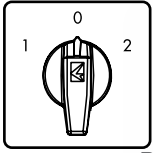

PSA020MS334S

Ürün Kodu	Faz Sayısı	Anma Termik Akımı (A)	Kademe	Uygun Kutu Kodu	Anahtarlı Kafa Uyarlanabilir	Çabuk Montaj	Kontakt Şeması
Code	Poles	Rated Thermal Current (A)	Steps	Enclosure	Key Operated	Quick Installation	Scheme
PSA010MS334S	3 Faz / Phase	10	1-0-2	PSK12	✓	✓	
PSA016MS334S	3 Faz / Phase	16	1-0-2	PSK12	✓	✓	
PSA020MS334S	3 Faz / Phase	20	1-0-2	PSK12	✓	✓	
PSA025MS334S	3 Faz / Phase	25	1-0-2	PSK12	✓	✓	
PSA032MS334S	3 Faz / Phase	32	1-0-2	PSK22			
PSA040MS334S	3 Faz / Phase	40	1-0-2	PSK22			
PSA050MS334S	3 Faz / Phase	50	1-0-2	-			
PSA063MS334S	3 Faz / Phase	63	1-0-2	-			
PSA080MS334S	3 Faz / Phase	80	1-0-2	-			
PSA120MS334S	3 Faz / Phase	120	1-0-2	-			

### 3 Faz Çift Devir Şalterler (0-1-2) / 3 Phase Double Cycle Cam Switches (0-1-2)

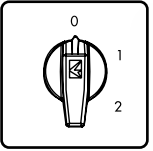

PSA016CD332S

Ürün Kodu	Faz Sayısı	Anma Termik Akımı (A)	Uygun Kutu Kodu	Anahtarlı Kafa Uyarlanabilir	Çabuk Montaj	Kontakt Şeması
Code	Steps	Rated Thermal Current (A)	Enclosure	Key Operated	Quick Installation	Scheme
PSA010CD332S	3 Faz / Phase	10	PSK12	✓	✓	
PSA016CD332S	3 Faz / Phase	16	PSK12	✓	✓	
PSA020CD332S	3 Faz / Phase	20	PSK12	✓	✓	
PSA025CD332S	3 Faz / Phase	25	PSK12	✓	✓	
PSA032CD332S	3 Faz / Phase	32	PSK22			
PSA040CD332S	3 Faz / Phase	40	PSK22			
PSA050CD332S	3 Faz / Phase	50	-			
PSA063CD332S	3 Faz / Phase	63	-			
PSA080CD332S	3 Faz / Phase	80	-			
PSA120CD332S	3 Faz / Phase	120	-			

### 3 Faz Çift Devir Şalterler (1-0-2) / 3 Phase Double Cycle Cam Switches (1-0-2)

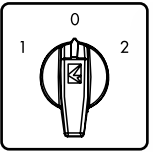

PSA016CD334S

Ürün Kodu	Faz Sayısı	Anma Termik Akımı (A)	Uygun Kutu Kodu	Anahtarlı Kafa Uyarlanabilir	Çabuk Montaj	Kontakt Şeması
Code	Steps	Rated Thermal Current (A)	Enclosure	Key Operated	Quick Installation	Scheme
PSA010CD334S	3 Faz / Phase	10	PSK12	✓	✓	
PSA016CD334S	3 Faz / Phase	16	PSK12	✓	✓	
PSA020CD334S	3 Faz / Phase	20	PSK12	✓	✓	
PSA025CD334S	3 Faz / Phase	25	PSK12	✓	✓	
PSA032CD334S	3 Faz / Phase	32	PSK22			
PSA040CD334S	3 Faz / Phase	40	PSK22			
PSA050CD334S	3 Faz / Phase	50	-			
PSA063CD334S	3 Faz / Phase	63	-			
PSA080CD334S	3 Faz / Phase	80	-			
PSA120CD334S	3 Faz / Phase	120	-			

- İstendiği takdirde sarı kırmızı kafa ile tedarik edilir. Bu durumda son harf "S" yerine "E" olmalıdır. Fiyat farkı uygulanmamaktadır.
- *Could be supplied with Red-Yellow head w/o extra charge, in this case please replace the "S" at the end with "E"*
- İstendiği takdirde, 10-25A bir büyük boy çerçeve ile montaj yapılabilir (64x64), bu durumda sondaki "S" yerine "B" konması gerekmektedir.
- *10-25A Cam switches could be supplied with big frame (64x64) with extra charge. In this case please replace the "S" at the end with "B".*
- Anahtarlı sütunda işaretli olan modeller çabuk montajlı Anahtarlı Kafa için uygundur.
- *Products in the Key Operated column are available for quick release Key Head.*
- Q Çabuk montajlı modellerde sondaki "S" yerine "Q" konması gerekmektedir.
- *Please replace "S" letter at the end of the code with "Q" letter for quick installation model.*

# Pako Şalterler ve Pako Kutuları

## Rotary Cam Switches

EMES®

### Ölçü Komütatörler - 45° / Measuring Cam Switches - 45°

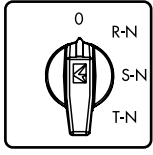

PSA0200K421S

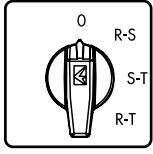

PSA0200K422S

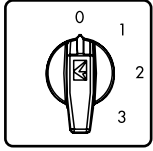

PSA0200K426S

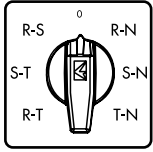

PSA0200K723S



Ürün Kodu Code	Tip Type	Anma Termik Akımı (A) Rated Thermal Current (A)	Pozisyon Position	Uygun Kutu Kodu Enclosure	Anahtarlı Kafa Uyarlanabilir Key Operated	Çabuk Montaj Quick Installation	Kontakt Şeması Scheme
PSA0100K421S	4	10	Voltmetre / Voltmeter	PSK11		✓	
PSA0160K421S	4	16	Voltmetre / Voltmeter	PSK11		✓	
PSA0200K421S	4	20	Voltmetre / Voltmeter	PSK11		✓	
PSA0100K422S	4	10	Faz-Faz Voltmetre Phase-Phase Voltmeter	PSK11		✓	
PSA0160K422S	4	16	Faz-Faz Voltmetre Phase-Phase Voltmeter	PSK11		✓	
PSA0200K422S	4	20	Faz-Faz Voltmetre Phase-Phase Voltmeter	PSK11		✓	
PSA0100K426S	4	10	Ampermetre / Ammeter	PSK12		✓	
PSA0160K426S	4	16	Ampermetre / Ammeter	PSK12		✓	
PSA0200K426S	4	20	Ampermetre / Ammeter	PSK12		✓	
PSA0100K723S	7	20	Ampermetre / Ammeter	PSK12		✓	
PSA0160K723S	7	20	Ampermetre / Ammeter	PSK12		✓	
PSA0200K723S	7	20	Voltmetre / Voltmeter	PSK12		✓	

• Q Çabuk montajlı modellerde sondaki "S" yerine "Q" konması gerekmektedir.

\* Please replace "S" letter at the end of the code with "Q" letter for quick installation model.

### Aksesuarlar / Accessories



PSR1



PSR2

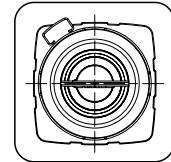

PSA020AK131AQ



PSA010KD134Q



PSA020AK131K

# Pako Şalterler ve Pako Kutuları

## Rotary Cam Switches

EMES®

Montaj Şekilleri ve Boyutları (mm) / Assembly Type and Dimensions (mm)

### STANDART PAKO / STANDARD CAM SWITCHES

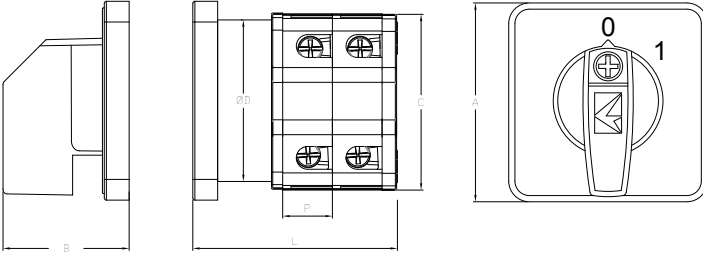

	A	B	C	D
PSA10	48	30,5	42,5	27
PSA16	48	30,5	42,5	27
PSA20	48	30,5	42,5	27
PSA25	48	30,5	42,5	27
PSA32	64	38	55	55
PSA40	64	38	55	55
PSA50	64	38	55	55
PSA63	64	38	55	55
PSA80	85	43	75	75
PSA120	95	43	85	85

### EMNİYET PAKO / SAFETY CAM SWITCHES

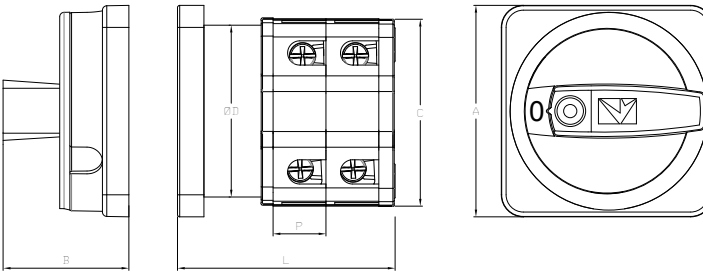

	A	B	C	D
PSA10	48	28,5	42,5	27
PSA16	48	28,5	42,5	27
PSA20	48	28,5	42,5	27
PSA25	48	28,5	42,5	27
PSA32	64	36	55	55
PSA40	64	36	55	55
PSA50	64	36	55	55
PSA63	64	36	55	55
PSA80	85	41	75	75
PSA120	95	41	85	85

### TUTAMAKTAN KİLİTLİ PAKO / PADLOCKABLE HANDLE CAM SWITCHES

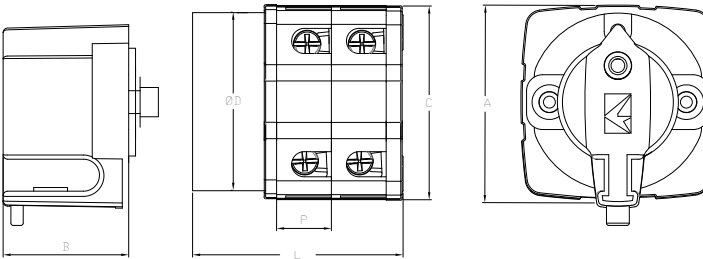

	A	B	C	D
PSA10	48	27,5	42,5	27
PSA16	48	27,5	42,5	27
PSA20	48	27,5	42,5	27
PSA25	48	27,5	42,5	27
PSA32	64	36	55	55
PSA40	64	36	55	55
PSA50	64	36	55	55
PSA63	64	36	55	55
PSA80	85	41	75	75
PSA120	95	41	85	85

### ÇABUK MONTAJ STANDART PAKO / QUICK INSTALLATION CAM SWITCHES

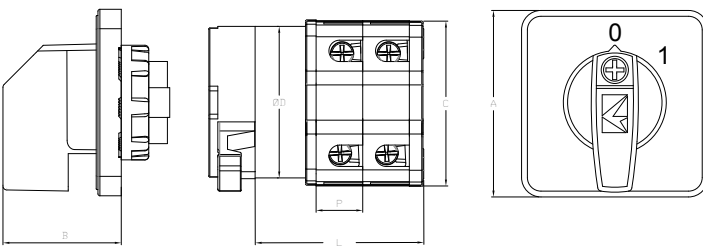

	A	B	C	D
PSA10	48	31	42,5	27
PSA16	48	31	42,5	27
PSA20	48	31	42,5	27
PSA25	48	31	42,5	27
PSA32	64	40	55	55
PSA40	64	40	55	55
PSA50	64	40	55	55
PSA63	64	40	55	55
PSA80	85	45	75	75
PSA120	95	45	85	85

# Pako Şalterler ve Pako Kutuları

## Rotary Cam Switches

EMAS®

### Montaj Şekilleri ve Boyutları (mm) / Assembly Type and Dimensions (mm)

#### ÇABUK MONTAJ EMNİYET PAKO / QUICK INSTALLATION SAFETY CAM SWITCHES

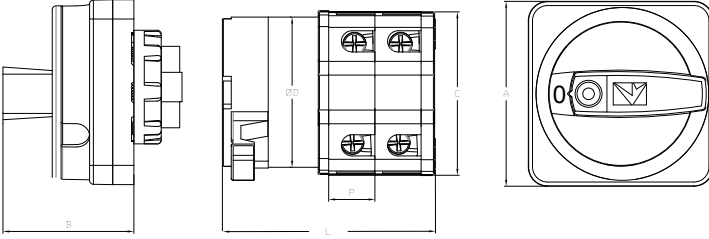

	A	B	C	D
PSA10	48	34	42,5	27
PSA16	48	34	42,5	27
PSA20	48	34	42,5	27
PSA25	48	34	42,5	27
PSA32	64	43	55	55
PSA40	64	43	55	55
PSA50	64	43	55	55
PSA63	64	43	55	55
PSA80	85	48	75	75
PSA120	95	48	85	85

#### ANAHTARLI PAKO (ÇABUK MONTAJ) / KEY OPERATED ( QUICK INSTALLATION ) CAM SWITCHES

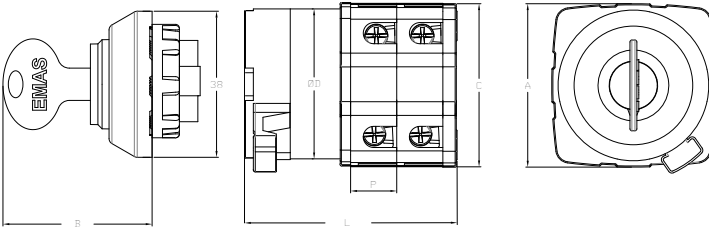

	A	B	C	D
PSA10	48	39,5	42,5	27
PSA16	48	39,5	42,5	27
PSA20	48	39,5	42,5	27
PSA25	48	39,5	42,5	27
PSA32	64	48	55	55
PSA40	64	48	55	55
PSA50	64	48	55	55
PSA63	64	48	55	55
PSA80	85	53	75	75
PSA120	95	53	85	85

#### BAĞLANTI VE GENEL ÖLÇÜLER / CONNECTION AND GENERAL DIMENSIONS

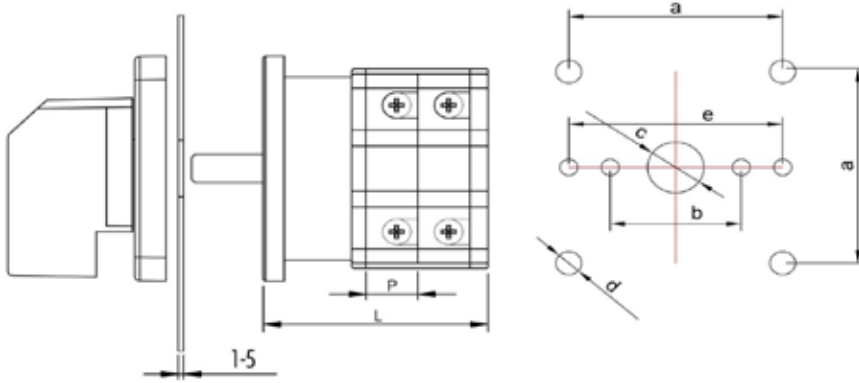

L	Gövde Sayısı / Contact Block Quantity								
	P	1	2	3	4	5	6	7	8
PSA10	10	33,2	43,2	53,2	63,2	73,2	83,2	93,2	103,2
PSA16	10	33,2	43,2	53,2	63,2	73,2	83,2	93,2	103,2
PSA20	10	33,2	43,2	53,2	63,2	73,2	83,2	93,2	103,2
PSA25	12	35,2	47,2	59,2	71,2	83,2	95,2	107,2	119,2
PSA32	13	39,2	52,2	65,2	78,2	91,2	104,2	117,2	130,2
PSA40	15	41,2	56,2	71,2	86,2	101,2	116,2	131,2	146,2
PSA50	17,5	43,7	61,2	78,7	96,2	113,7	131,2	148,7	166,2
PSA63	21	47,2	68,2	89,2	110,2	131,2	152,2	173,2	194,2
PSA80	26	63	89	115	141	167	193	219	245
PSA120	30	63	93	123	153	183	213	243	273

	b	b	c	d
PSA10	36	30	9,5	4,3
PSA16	36	30	9,5	4,3
PSA20	36	30	9,5	4,3
PSA25	36	30	9,5	4,3
PSA32	48	30	50	10
PSA40	48	30	50	10
PSA50	48	30	50	10
PSA63	48	30	50	10
PSA80	68	38	50	13
PSA120	68	38	50	13

# Pako Şalterler ve Pako Kutuları

## Rotary Cam Switches

EMES®

### Pako Kutular / Cam Switch Boxes



PSK11



PSK21



PSK12



PSK22

### PAKO Kutuları / Cam Switch Enclosures

Ürün Kodu / Code	Malzeme / Material	Özellik / Features
PSK11	Plastik / Plastic	IP54
PSK12	Plastik / Plastic	IP54
PSK21	Plastik / Plastic	IP54
PSK22	Plastik / Plastic	IP54
PSK11E	Plastik / Plastic	IP65
PSK12E	Plastik / Plastic	IP65
PSK21E	Plastik / Plastic	IP65
PSK22E	Plastik / Plastic	IP65

### Montaj Ölçüleri (mm) / Mounting Dimensions (mm)

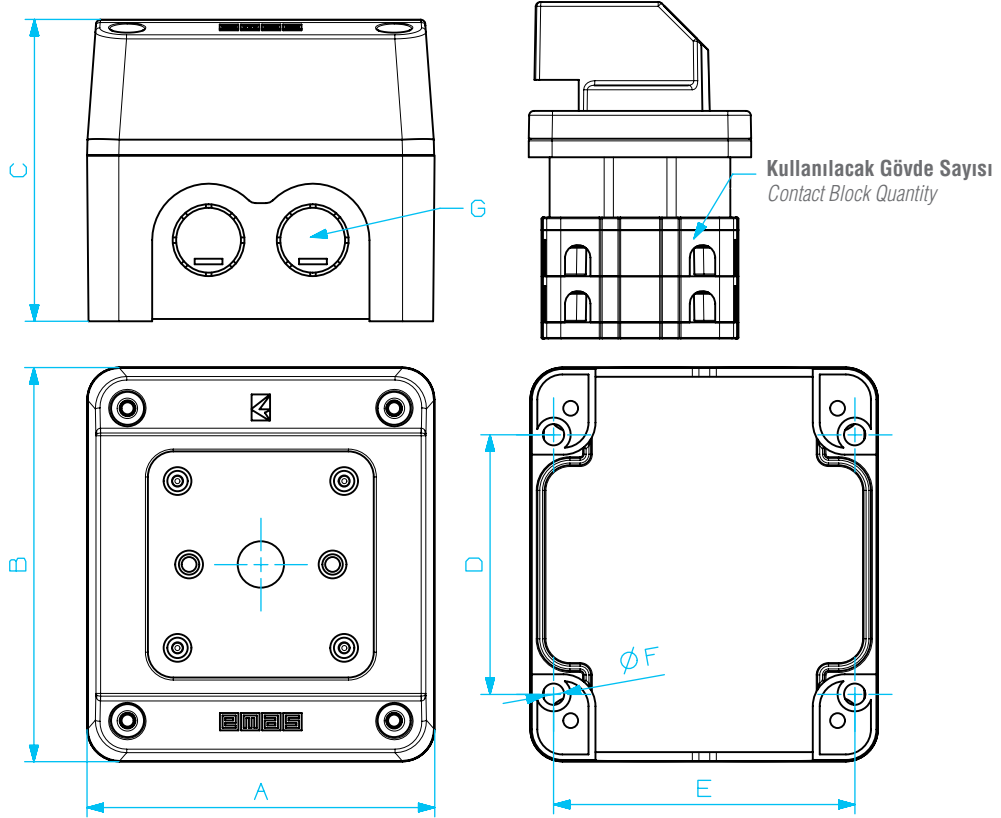

Ürün Kodu / Code	Montaj Ölçüleri / Mounting Dimensions					Rakor / Cable Gland	
	A	B	C	D	E	F	G
PSK11	75	85	65	56	65	4,6	PG9
PSK12	75	85	89	56	65	4,6	PG9
PSK21	91	101	73,5	72	81	4,6	PG11
PSK22	91	101	103,5	72	82	4,6	PG11

Ürün Kodu / Code	Kullanılan Pako Gövde Sayısı / Contact Block Quantity
PSK11	10A - 25A arası 1 ve 2 gövdeli Pako Şalterler / For 10 - 25 A Cam Switches and for 1 and 2 contact block
PSK12	10A - 25A arası 3 ve 4 gövdeli Pako Şalterler / For 10 - 25 A Cam Switches and for 3 and 4 contact block
PSK21	32A - 40A arası 1 ve 2 gövdeli Pako Şalterler / For 32A - 40A Cam Switches and for 1 and 2 contact block
PSK22	32A - 40A arası 3 ve 4 gövdeli Pako Şalterler / For 32A - 40A Cam Switches and for 3 and 4 contact block



# Pako Şalterler ve Pako Kutuları

## Rotary Cam Switches



### Teknik Özellikler / Technical Specifications

Siviç Tipi / Switch Type				PSA010	PSA016	PSA020	PSA25	PSA32	PSA040	PSA050	PSA063	PSA080	
İzolasyon gerilimi	Rated Insulation Voltage <i>Ui</i>	<b>kV</b>		400				690					
Darbe dayanım gerilimi	Rated impulse withstand Voltage <i>Uimp</i>	<b>kV</b>		4				4					
Anlık termal akım	Rated thermal current <i>Ith</i>	<b>A</b>	16	20	25	32	40	50	50	70	80		
Ana Şalter İşletme geriliminin maksimum değeri	Main Switch Max. value of rated operational voltage	<b>V</b>	480										
Darbe dayanım gerilimi	Rated impulse withstand voltage	<b>kV</b>	4										
Kısa devre koruması için max. sigorta boyutu	Max. fuse size for short circuit protection <i>gL 10kA</i>	<b>A</b>	16	20	25	32	40	50	50	70	80		
Kısa devre akımına 1 sn. dayanma süresi	Rated short-time withstand current <i>Icw</i>	1 sec	<b>A</b>	150	180	200	400	600	800	800	800	1000	
		3 sec	<b>A</b>	100	110	120	250	400	530	700	700	800	
		10 sec	<b>A</b>	50	60	70	140	240	290	350	350	400	
		30 sec	<b>A</b>	25	30	40	90	150	200	250	250	250	
		60 sec	<b>A</b>	20	25	30	70	120	150	150	150	160	
Anma işletme akımı	Rated operational current <i>Ie AC1 / AC21</i>	<b>A</b>	10	16	20	25	32	40	50	63	70		
Anma işletme akımı	Rated operational current <i>Ie AC15</i>	110 V	<b>A</b>	8	8	10	20	25	40	50	50	63	
		220/230 V	<b>A</b>	8	8	8	20	25	40	50	50	63	
		380/400 V	<b>A</b>	4	4	6	16	20	25	40	40	45	
		660/690 V	<b>A</b>				8	8.5	8.5	10	10	10	
Kullanma sınıfı AC3	Motor switch in utilization category AC3	3 faz	220/230 V	<b>kW</b>	1.5	3	3	5.5	7.5	9	11	11	12
			380/400 V	<b>kW</b>	1.6	5	5	7.5	11	15	18.5	18.5	22
			500/690 V	<b>kW</b>	4	6	8.5	11	15	19	22	22	28
		1 faz 2 kutup	110 V	<b>kW</b>	0.5	0.8	0.8	1.5	2.5	3	-	-	-
			220/230 V	<b>kW</b>	1.5	2.5	3	5.5	6.5	7.5	-	-	-
			380/400 V	<b>kW</b>	2	2.5	3	5.5	6.5	7.5	-	-	-
AC23	AC23	3 faz	220/230 V	<b>kW</b>	3	5	5	6.5	8	9	15	15	18.5
			380/400 V	<b>kW</b>	5	7	7.5	11	15	18.5	22	22	32
			500/690 V	<b>kW</b>	-	-	-	11	18.5	22	30	30	45
		1 faz 2 kutup	110 V	<b>kW</b>	0.8	0.8	0.8	1.5	2.5	3	3.5	3.5	-
			220/230 V	<b>kW</b>	1.7	2.5	2.5	3.7	5	6	9	9	-
			380/400 V	<b>kW</b>	2.8	3.7	3.7	5.5	7.5	9	15	15	-
AC4	AC4	3 faz	220/230 V	<b>kW</b>	0.75	1	1.5	2.5	3	5	6	6	7
			380/400 V	<b>kW</b>	1	1.5	2	4	5.5	8	11	11	12
			500/690 V	<b>kW</b>	-	-	-	4	7.5	8	11	11	12
Mekanik dayanım şalterleme devri	Mechanical Endurance switching cycles	<b>10<sup>5</sup></b>	1	1	1	1	1	1	1	1	1		
Vida bağlantıları	Terminal Screw		M3.5	M3.5	M3.5	M3.5	M4	M4	M5	M5	2XM5		
Bağlantı kablosu kesiti	Cable cross section	rijit flexible	<b>mm<sup>2</sup></b>	2X(1-2.5) 2-4*	2X(1-2.5) 2-4*	2X(1-2.5) 2-4*	2X(1-4) 1-6*	2X(2.5-6) 1-10*	2X (2.5-10)	2X(4-16)	2X(4-16)	10-25	
				2X(1-2.5) 2-4*	2X(1-2.5) 2-4*	2X(1-2.5) 2-4*	2X(1-4)	2X(2.5-6) 1-10*	2X (2.5-10)	2X(4-16)	2X(4-16)	6-16 2X(6-10)	

(1) Aşırı gerilim kategorisi III, kirlenme derecesi 3, nötr topraklı sistemler için geçerli.

(1) Valid for neutral earthed systems, overvoltage category III, pollution degree 3.

(\*) Dahili bağlantısı olmayan diagramlar için geçerlidir.

(\*) Only for diagrams without inside links.

# Pako Şalterler ve Pako Kutuları

## Rotary Cam Switches

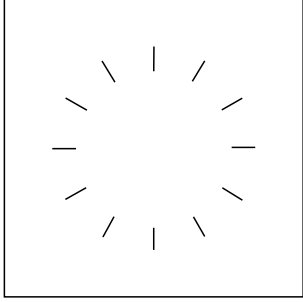
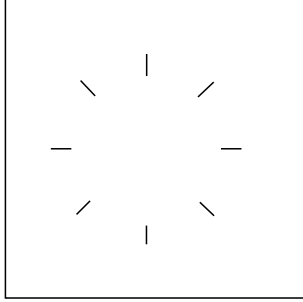

		ÖZEL SİPARİŞ FORMU SPECIAL ORDER FORM																																																																													
İşletme Gerilimi Rated Voltage	V	Şalter Tipi Type of Switch	PS	Montaj Formu Mounting Form	Diyagram No. Diagram No.																																																																										
İşletme Akımı Rated Current	A	Kullanma Kategorisi Utilization Category			Özel Versiyon Special Version																																																																										
Bağlantı Diyagramı Connection Diagram		Bağlantı Diyagramı Connection Diagram																																																																													
																																																																															
		<table border="1"> <tr> <td>1</td><td>4</td><td>5</td><td>8</td><td>9</td><td>12</td><td>13</td><td>16</td><td>17</td><td>20</td><td>21</td><td>24</td><td>25</td><td>28</td><td>29</td><td>32</td><td>33</td><td>36</td><td>37</td><td>40</td><td>41</td><td>44</td><td>45</td><td>48</td> </tr> <tr> <td></td><td></td><td></td><td></td><td></td><td></td><td></td><td></td><td></td><td></td><td></td><td></td><td></td><td></td><td></td><td></td><td></td><td></td><td></td><td></td><td></td><td></td><td></td><td></td> </tr> <tr> <td>2</td><td>3</td><td>6</td><td>7</td><td>10</td><td>11</td><td>14</td><td>15</td><td>18</td><td>19</td><td>22</td><td>23</td><td>26</td><td>27</td><td>30</td><td>31</td><td>34</td><td>35</td><td>38</td><td>39</td><td>42</td><td>43</td><td>46</td><td>47</td> </tr> </table>						1	4	5	8	9	12	13	16	17	20	21	24	25	28	29	32	33	36	37	40	41	44	45	48																									2	3	6	7	10	11	14	15	18	19	22	23	26	27	30	31	34	35	38	39	42	43	46	47
1	4	5	8	9	12	13	16	17	20	21	24	25	28	29	32	33	36	37	40	41	44	45	48																																																								
2	3	6	7	10	11	14	15	18	19	22	23	26	27	30	31	34	35	38	39	42	43	46	47																																																								
Devre Pozisyonu Düzenleme Tablosu Arrangement Of Position Marks On Front Plate																																																																															
Not: Note:																																																																															
		Firma Adı/Company Name _____ Adres/Address _____ _____ Tel./Telephone _____ Faks/Fax _____ Bilgi/Data _____																																																																													